



## RETAIL LIGHTING

### SPOTLIGHTS

GA LUMI  
GA FOCUS  
GA HALO  
GA ZENITH  
GA NOVA  
SÄDE  
GA AURA  
GA LUNA  
KAJO  
HOHDE  
KAJO C  
HALO A

### 1 - P H A S E

KIMMEL B  
LUMI B  
FOCUS B  
FOCUS P

### DOWNLIGHTS

AURA DL  
AURA S DL  
TAIKA DL  
FOCUS DL  
LOISTE DL  
LUNA DL S  
LUNA DL D  
LUNA DL T  
LUNA DL C  
VIVID DL S  
VIVID DL D  
VIVID DL T  
VIVID DL C  
QS NOVA S  
QS NOVA D  
QS HALO S  
QS HALO D

### P E N D A N T S

FOCUS P  
HARMA

**SKILUX VALAISTUS**  
[www.skilux.fi](http://www.skilux.fi)

# SKILUX COMPANY

# PROFILE

P A L V E L V A V A L A I S I N T U K K U

## TARINAMME

Skilux Oy on vuonna 1998 perustettu yksityinen ja itsenäinen valaisintukku. Valaistus- ja kiskotuotteiden lisäksi tarjoamme valaistussuunnittelua, tuotteidemme asennusta, huoltoa ja ylläpitoa. Olemme palveleva valaisintukku.

Skilux Oy:n toiminta on alkanut espoolaisesta autotallista ja yrityksen kotipaikka on edelleenkin Espoo. Toiminnan laajennuttua koko Suomen ja Euroopan alueelle, yritys hankki toimisto- sekä varastotilat Helsingistä. Tänä päivänä pääkonttorimme sekä noutovarastomme sijaitsevat Helsingin Konalassa. Toiminta-alueemme kattaa koko Suomen ja myyntiedustajamme ovatkin helposti tavoitettavissa ympäri Suomea. Tärkeitä arvoja yrityksellemme ovat asiakaspalvelu, luotettavuus ja joustava toiminta. Asiakkaan ongelmanratkaisu ja asiakastyytyväisyys ovat toimintamme perusta. Henkilökuntamme on motivoitunutta, koulutettua ja asiantuntevaa. Palvelemme asiakkaitamme kymmenien vuosien kokemuksella ja useimmat asiakkaamme ovatkin olleet asiakkainamme jo yli 20 vuotta. Tämä jo itsessään kertoo luotettavuudesta sekä tyytyväisistä asiakkaista.

## MISSIO

Skiluxin missiona on olla palveleva valaisintukku sekä asiakkaidemme luottokumppani kaikessa valaistukseen liittyvässä. Vuosien kokemus suomalaisen valaistusalan kehityksestä sekä liiketilaisiäsuostuksen trendeistä antaa meille vakaan perustan olemassa olevalle toiminnalle. Olemme valinneet tuotevalikoimaamme teknisesti korkealaatuiset ja kehityksen kärjessä olevien valmistajien tuotteet. Lisäksi laaja yhteistyöverkostomme on meille tärkeä, jotta pystymme toteuttamaan asiakaslupaukset sekä toimimaan täsmällisesti ja luotettavasti. Oli kyseessä sitten pieni tai iso projekti, me pystymme hoitamaan valaistuskokonaisuuden helposti ja vaivatta.

Skilux's mission is to be a serving lighting wholesaler and our customers' trusted partner in everything related to lighting. Years of experience in the development of the Finnish lighting industry and trends in commercial interior design give us a solid foundation for our existing operations. We have chosen for our product range technically high-quality products from manufacturers at the forefront of development. In addition, our extensive cooperation network is important to us in order to be able to fulfill customer promises and to act precisely and reliably. Whether it's a small or a large project, we can manage the lighting system easily and effortlessly.

## VISIO

Skilux on jo nyt saanut valaista tuhansia myymälä- ja liiketiloja kaikkialla Suomessa sekä muualla Euroopassa. Haluamme myös tulevaisuudessa toimia asiakkaidemme luotettavana yhteistyökumppanina ja asiantuntijana kaikessa valaistukseen liittyvässä. Työskentelemme sen eteen, että yhä useampi osaa olla meihin suoraan yhteydessä valaistustarpeissaan. Pyrimme lisäämään tietoisuutta osaamisestamme ja vuosien kokemuksestamme kaupan erityisvalaistuksesta sekä suurten valaisinprojektien toteutuksista. Haluamme tulevaisuudessa olla markkinajohtaja Suomen ja Baltian valaisinmarkkinoilla.

Skilux has already been able to illuminate thousands of shops and business premises all over Finland and elsewhere in Europe. In the future, we also want to act as our customers' reliable partner and expert in everything related to lighting. We are working to ensure that more and more people can contact us directly with their lighting needs. We strive to increase awareness of our know-how and our years of experience in special lighting for stores and the implementation of large lighting projects. In the future, we want to be the market leader in the Finnish and Baltic lighting markets.

**SKILUX VALAISTUS**  
www.skilux.fi

**luotettava  
kumppani**



## CASAMBI VALAISTUKSEN OHJAUS CASAMBI MANAGEMENT SYSTEM

Valaistuksen ohjauksesta on tullut olennainen osa erilaisten valaistuskokonaisuuksien muodostamista, jolla räätälöidään kunkin tilan valaistusympäristöä.

Valon merkitys ihmiselle on ollut tiedossa jo pitkään. Siksi oikean tasapainon löytäminen liikeilojen valaistuksessa on tärkeää ja näin saadaan suurin mahdollinen hyöty, joka heijastuu parempaan tuottavuuteen. Nykyaikaiset tekniikat mahdollistavat valoskenaarioiden moduloinnin yleisillä työkaluilla, kuten matkapuhelimella tai tableteilla, jotka on jo integroitu ihmisten jokapäiväistä elämää.

SKILUX:n ratkaisuihin on saatavilla langaton CASAMBI-tekniologia, jota on erittäin helppo hallita kaikilla nykyaikaisilla älypuhelimilla ja tableteilla, universaalin Bluetoothin yhteyden kautta, käyttäjän ja valaistuslaitteiden välillä. CASAMBI-tekniikka on integroitu valaisimiin, mikä luo optimaaliset käyttö- ja asennus- ja toimivuusolosuhteet sekä kustannustehokkuuden valaistusjärjestelmään. CASAMBI-komponentit muodostavat Mesh-viestintäverkon, jossa järjestelmän kaikki älykkyyden replikoituu jokaisessa yksittäisessä parissa, mikä tarkoittaa, että ei ole yksittäisiä vikoita, jotka voivat vahingoittaa koko viestintäverkkoa. Järjestelmä on itsekorjautuva ja jatkuva synkronoinnissa; tässä hajautetussa ja symmetrisessä arkkitehtuurissa jokainen yksikkö/laitte voidaan sammuttaa ja laite jatkaa toimintaansa heti, kun sen virransyöttö palautetaan.

Yksinkertainen APP mahdollistaa järjestelmän hallinnan, joka toimii käyttäjäliittymänä valaistuslaitteiden täsmälliseen tai ryhmäohjaukseen, työkaluna järjestelmän käyttöönnottoon ja etäyhdyksikäytävänä Cloud-yhteydelle. Järjestelmä on intuitiivinen, eikä vaadi sähköisiä yhteyksiä laitteiden välillä, ei kytkimiä eikä Internet-yhteyttä toimiakseen. Se on ihanteellinen järjestelmä olemassa olevan valaistusjärjestelmän nykyaikaistamiseen ilman rakenteellisia muutoksia.

The management of light has become an essential element to sculpt luminous scenarios that contribute to designing and personalizing the luminous environment around the person.

It has long been known the great contribution that light offers to the well-being of the person, to make them find the right balance with spaces and derive the maximum physical benefit that is reflected in greater productivity and better involvement. Modern technologies allow to modulate the luminous scenarios using common tools such as a mobile phone or a tablet, now integrated into the daily life of people.

SKILUX's solutions include the available CASAMBI technology, which is very easy to control with modern smartphones and tablets, through a universal Bluetooth connection, between the user and the lighting equipment. CASAMBI technology is integrated into the luminaires, creating optimal operation, installation and delivery, as well as cost efficiency in the lighting system.

CASAMBI components form a Mesh communication network, where the system's all intelligence is replicated in each individual pair, which means that there are no damaged points of failure that can damage the entire communication structure. System correcting and in my continuous self; in this distributed and symmetric architecture, the entire unit/device shuts down and the device resumes operation as soon as its power supply is restored.

A simple APP allows to manage the system, working as a user interface for the punctual or group control of the lighting devices, as a tool for the commissioning of the system and as a remote gateway for the connection with the Cloud. The system is intuitive, does not require electrical connections between the devices (bus line), switches and does not require an Internet connection to operate. It is the ideal system to modernize an existing lighting system without structural interventions.



CASAMBI

Le mie reti  
Dispositivi vicini  
Site  
Account  
Mostra demo

1	2	3	4	5	6	7	8
			10	11	12	13	14
				16	17	18	19
21	22	23	24	26	25	26	26
			27	29	28	29	29
						31	32



## TEKNISET TIEDOT / TECHNICAL INFORMATION

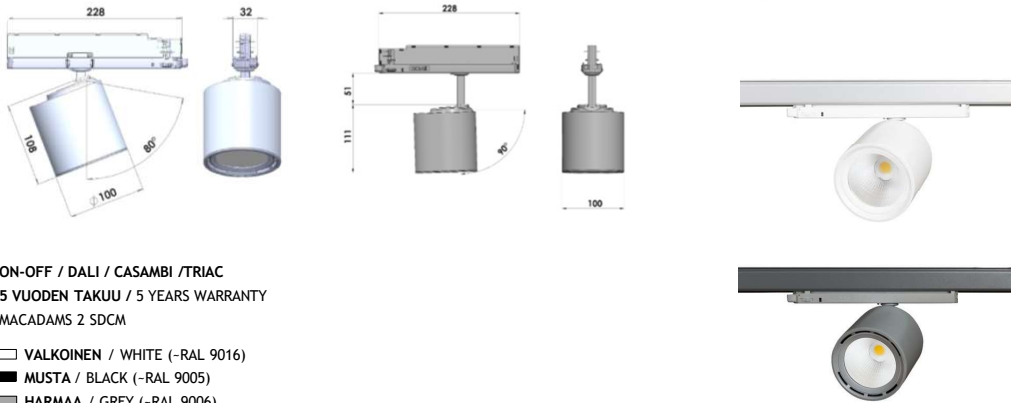

ON-OFF / DALI / CASAMBI / TRIAC  
5 VUODEN TAKUU / 5 YEARS WARRANTY  
MACADAMS 2 SDCM

- VALKOINEN / WHITE (-RAL 9016)  
■ MUSTA / BLACK (-RAL 9005)  
■ HARMAA / GREY (-RAL 9006)



VALOVIRRRAN YLLÄPITO / LIFETIME 55 000H (L80 B10)  
MATERIAALI / MATERIAL RUNKO PULVERIMAALATTU ALUMIINIA / POWDER PAINTED ALUMINUM  
ASENNUS / INSTALLATION KISKOKIINNITYS / TRACK MOUNTED

## Valaisin (LOR90%), netto

Teho W	Virta mA	CRI90				Meat		Bakery
		2700K CRI90 CITILED COB Series Version3 CLU03Q-1206E1-27ZHSY2	3000K CRI90 Fortimo SLM C 930 Pw 1208 L15 2024 G7 HE+	3500K CRI90 Fortimo SLM C 935 Pw 1208 L15 2024 G7 HE+	4000K CRI90 Fortimo SLM C 340 Pw 1208 L15 2024 G7 HE+	CITILED COB Series CLU038-1208C4-205HHK4	CITILED COB Series CLU038-1208C4-244HJK4	
13	300	1368	1418	1464	1417	750	885	
15	350	1596	1655	1708	1653	875	1033	
18	400	1823	1891	1951	1889	1001	1180	
20	450	2051	2128	2195	2125	1126	1328	
22	500	2279	2364	2439	2361	1251	1475	
24	550	2507	2600	2683	2597	1376	1623	
27	600	2735	2837	2927	2834	1501	1770	
29	650	2963	3073	3171	3070	1626	1918	
31	700	3191	3310	3415	3306	1751	2065	
33	750	3419	3546	3659	3542	1876	2213	
35	800	3647	3782	3903	3778	2001	2361	
36	850	3875	4019	4147	4014	2126	2508	
38	900	4103	4255	4391	4250	2251	2656	
40	950	4331	4492	4635	4487	2376	2803	
42	1000	4559	4728	4879	4723	2501	2951	
44	1050	4787	4964	5123	4959	2626	3098	

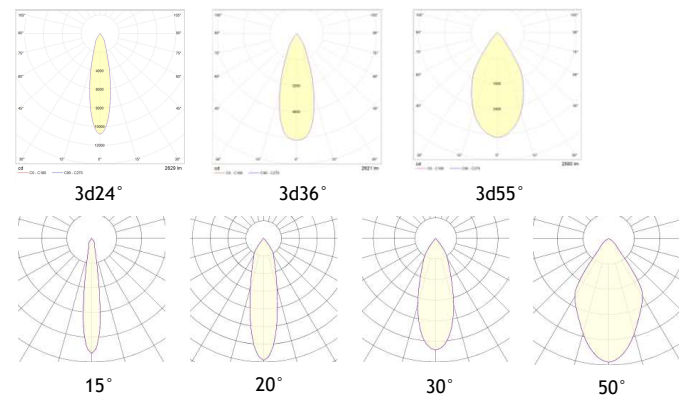

# GA SATURNUS

## TEKNISET TIEDOT / TECHNICAL INFORMATION

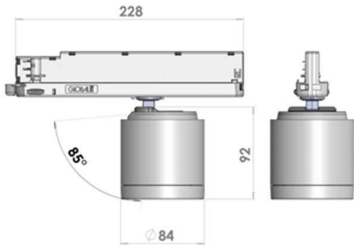

ON-OFF / DALI / CASAMBI / TRIAC  
5 VUODEN TAKUU / 5 YEARS WARRANTY  
MACADAMS 2 SDCM

- VALKOINEN / WHITE (-RAL 9016)
- MUSTA / BLACK (-RAL 9005)
- HARMAA / GREY (-RAL 9006)



VALOVIRRRAN YLLÄPITO / LIFETIME 55 000H (L80 B10)  
MATERIAALI / MATERIAL RUNKO PULVERIMAALATTUA ALUMIINIÄ / POWDER PAINTED ALUMINUM  
ASENNUS / INSTALLATION KISKOKIINNITYS / TRACK MOUNTED



Valaisin (LOR90%), netto							
Teho W	Virta mA	2700K CRI90 CITILED COB Series / Version3 CLU030Q-1208E1-272HSY2	3000K CRI90 Fortimo SLM C 930 Pw/ 1208 L15 2024 G7 HE+	3500K CRI90 Fortimo SLM C 935 Pw/ 1208 L15 2024 G7 HE+	4000K CRI90 Fortimo SLM C 940 Pw/ 1208 L15 2024 G7 HE	Meat CITILED COB Series CLU038-1208C4-205H1K4	Bakery CITILED COB Series CLU038-1208C4-244HJK4
13	300	1368	1418	1464	1417	750	885
15	350	1596	1655	1708	1653	875	1033
18	400	1823	1891	1951	1889	1001	1180
20	450	2051	2128	2195	2125	1126	1328
22	500	2279	2364	2439	2361	1251	1475
24	550	2507	2600	2683	2597	1376	1623
27	600	2735	2837	2927	2834	1501	1770
29	650	2963	3073	3171	3070	1626	1918
31	700	3191	3310	3415	3306	1751	2065
33	750	3419	3546	3659	3542	1876	2213
35	800	3647	3782	3903	3778	2001	2361
36	850	3875	4019	4147	4014	2126	2508

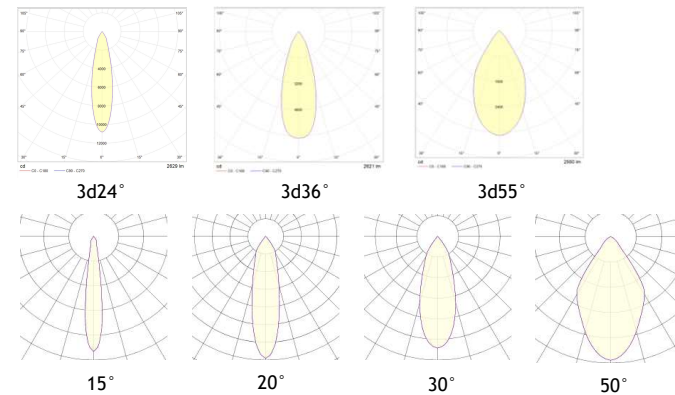

# GA LUNA

## TEKNISET TIEDOT / TECHNICAL INFORMATION

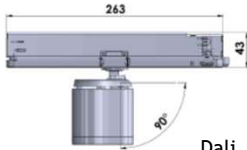
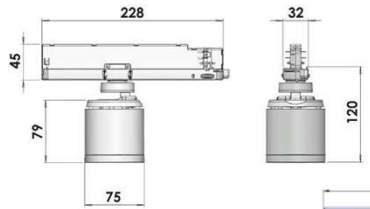

ON-OFF / DALI / CASAMBI / TRIAC  
5 VUODEN TAKUU / 5 YEARS WARRANTY  
MACADAMS 2 SDCM

- VALKOINEN / WHITE (-RAL 9016)
- MUSTA / BLACK (-RAL 9005)
- HARMAA / GREY (-RAL 9006)



VALOVIRRRAN YLLÄPITO / LIFETIME 55 000H (L80 B10)  
MATERIAALI / MATERIAL RUNKO PULVERIMAALATTUUA ALUMIINIA / POWDER PAINTED ALUMINUM  
ASENNUS / INSTALLATION KISKOKIINNITYS / TRACK MOUNTED

Dali  
GAC-616 Casa



### Valaisin (LOR90%), netto

Teho W	Virta mA	2700K CRI90	3000K CRI90	3500K CRI90	4000K CRI90	Meat	Bakery
		CITILED COB Series Version3 CLU03Q-1206E1-272HSY2	Fortimo SLMC 930 P/W 1208 L15 2024 G7 HE+	Fortimo SLMC 935 P/W 1208 L15 2024 G7 HE+	Fortimo SLMC 940 P/W 1208 L15 2024 G7 HE	CITILED COB Series CLU038-1208C4-205H-HK4	CITILED COB Series CLU038-1208C4-244H-HK4
13	300	1368	1418	1464	1417	750	885
15	350	1596	1655	1708	1653	875	1033
18	400	1823	1891	1951	1889	1001	1180
20	450	2051	2128	2195	2125	1126	1328
22	500	2279	2364	2439	2361	1251	1475
24	550	2507	2600	2683	2597	1376	1623
27	600	2735	2837	2927	2834	1501	1770
29	650	2963	3073	3171	3070	1626	1918
31	700	3191	3310	3415	3306	1751	2065
33	750	3419	3546	3659	3542	1876	2213

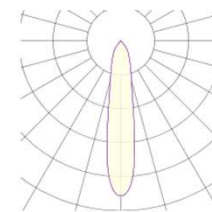

15°

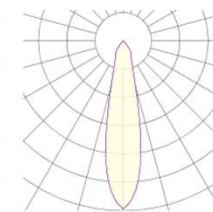

21°

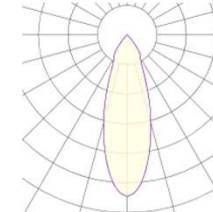

32°

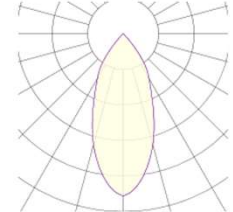

46°



## GA LUMI

## TEKNISET TIEDOT / TECHNICAL INFORMATION

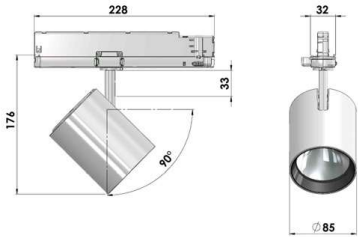

ON-OFF / DALI / CASAMBI / TRIAC  
5 VUODEN TAKUU / 5 YEARS WARRANTY  
MACADAMS 2 SDCM

- VALKOINEN / WHITE (-RAL 9016)  
 MUSTA / BLACK (-RAL 9005)  
 HARMAA / GREY (-RAL 9006)



VALOVIRRRAN YLLÄPITO / LIFETIME 55 000H (L80 B10)  
MATERIAALI / MATERIAL RUNKO PULVERIMAALATTUA ALUMIINIA / POWDER PAINTED ALUMINUM  
ASENNUS / INSTALLATION KISKOKIINNITYS / TRACK MOUNTED



Valaisin (LOR90%), netto							
Teho W	Virta mA	2700K CRI90 CITILED COB Series Version3 CLU03CQ-1208E1-27ZHSY2	3000K CRI90 Fortimo SLM C 930 Pw/ 1208 L15 2024 G7 HE+	3500K CRI90 Fortimo SLM C 935 Pw/ 1208 L15 2024 G7 HE+	4000K CRI90 Fortimo SLM C 940 Pw/ 1208 L15 2024 G7 HE	Meat CITILED COB Series CLU038-1208C4-205HKK4	Bakery CITILED COB Series CLU038-1208C4-244HJK4
13	300	1368	1418	1464	1417	750	885
15	350	1596	1655	1708	1653	875	1033
18	400	1823	1891	1951	1889	1001	1180
20	450	2051	2128	2195	2125	1126	1328
22	500	2279	2364	2439	2361	1251	1475
24	550	2507	2600	2683	2597	1376	1623
27	600	2735	2837	2927	2834	1501	1770
29	650	2963	3073	3171	3070	1626	1918
31	700	3191	3310	3415	3306	1751	2065
33	750	3419	3546	3659	3542	1876	2213
35	800	3647	3782	3903	3778	2001	2361
36	850	3875	4019	4147	4014	2126	2508

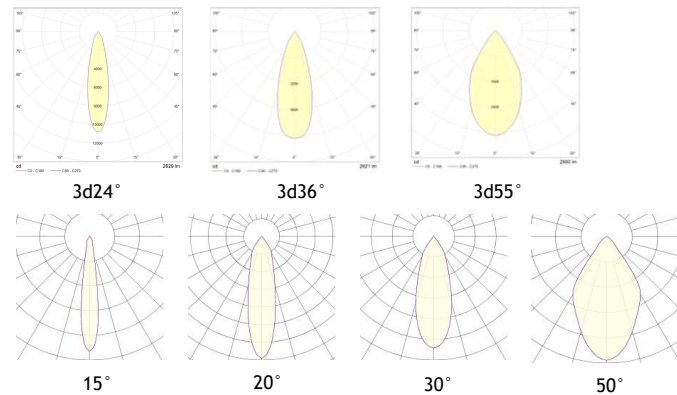

# GA FOCUS

## TEKNISET TIEDOT / TECHNICAL INFORMATION

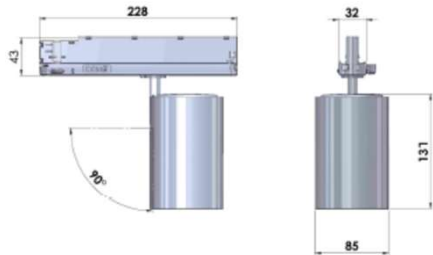

ON-OFF / DALI / CASAMBI / TRIAC  
5 VUODEN TAKUU / 5 YEARS WARRANTY  
MACADAMS 2 SDCM

- VALKOINEN / WHITE (-RAL 9016)
- MUSTA / BLACK (-RAL 9005)
- HARMAA / GREY (-RAL 9006)



VALOVIRRRAN YLLÄPITO / LIFETIME 55 000H (L80 B10)  
MATERIAALI / MATERIAL RUNKO PULVERIMAALATTUA ALUMIINIA / POWDER PAINTED ALUMINUM  
ASENNUS / INSTALLATION KISKOKIINNITYS / TRACK MOUNTED



### Valaisin (LOR90%), netto

Teho W	Virta mA	2700K CRI90 CITILED COB Series Version3 CLU03Q-1206E1-27ZHSY2	3000K CRI90 Fortimo SLM C 930 Pw 1208 L15 2024 G7 HE+	3500K CRI90 Fortimo SLM C 935 Pw 1208 L15 2024 G7 HE+	4000K CRI90 Fortimo SLM C 340 Pw 1208 L15 2024 G7 HE	Meat CITILED COB Series CLU038-1208C4-205HK4	Bakery CITILED COB Series CLU038-1208C4-244HK4
13	300	1368	1418	1464	1417	750	885
15	350	1596	1655	1708	1653	875	1033
18	400	1823	1891	1951	1889	1001	1180
20	450	2051	2128	2195	2125	1126	1328
22	500	2279	2364	2439	2361	1251	1475
24	550	2507	2600	2683	2597	1376	1623
27	600	2735	2837	2927	2834	1501	1770
29	650	2963	3073	3171	3070	1626	1918
31	700	3191	3310	3415	3306	1751	2065
33	750	3419	3546	3659	3542	1876	2213
35	800	3647	3782	3903	3778	2001	2361
36	850	3875	4019	4147	4014	2126	2508
38	900	4103	4255	4391	4250	2251	2656
40	950	4331	4492	4635	4487	2376	2803
42	1000	4559	4728	4879	4723	2501	2951
44	1050	4787	4964	5123	4959	2626	3098

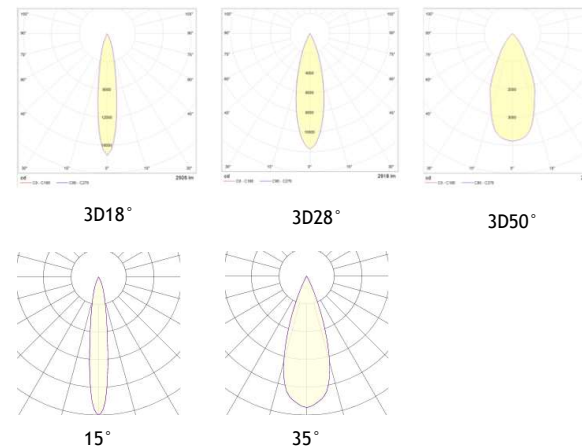

## GLEAM A



## TEKNISET TIEDOT / TECHNICAL INFORMATION

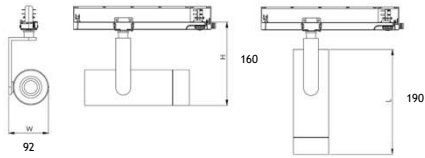

ON-OFF / DALI / CASAMBI / TRIAC  
5 VUODEN TAKUU / 5 YEARS WARRANTY  
MACADAMS 3 SDCM

□ VALKOINEN / WHITE (-RAL 9016)  
■ MUSTA / BLACK (-RAL 9017)



VALOVIRRRAN YLLÄPITO / LIFETIME 60 000H (L80 B10)  
MATERIAALI / MATERIAL RUNKO PULVERIMAALATTUA ALUMIINIA / POWDER PAINTED ALUMINUM  
ASENNUS / INSTALLATION KISKOKIINNITYS / TRACK MOUNTED

Valovirta lm	Teho W	Tehokkuus lm/W	CRI	CCT*, K	PAINO, kg
1946	13,5	144	80+	4000	1,1
2644	18,7	141	80+	4000	1,1
3559	26,5	134	80+	4000	1,1
4464	34,0	131	80+	4000	1,1

SAATAVILLA OLEVAT VERSIOT /  
OPTIONS AVAILABLE ON REQUEST:

LED		CONTROL GEAR
T830	T930 VEGETABLES	DALI <sup>1</sup>
T840	T932 FASHION	BLT
T930	T931 FASHION&WHITE	KRBLT
T940	T927 NATURAL	ROTARY DIM <sup>2</sup>
T820 MEAT	T930 NATURAL	
T831 MEAT&WHITE	T940 NATURAL	
T825 BREAD		



R20-60

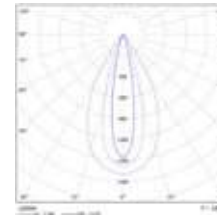



# GA AURA



## TEKNISET TIEDOT / TECHNICAL INFORMATION

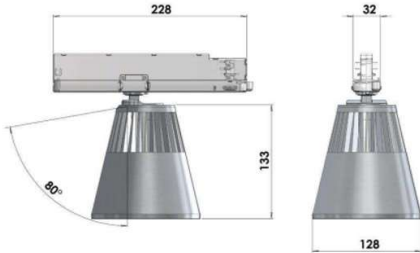

ON-OFF / DALI / CASAMBI / TRIAC  
5 VUODEN TAKUU / 5 YEARS WARRANTY  
MACADAMS 2 SDCM

- VALKOINEN / WHITE (-RAL 9016)
- MUSTA / BLACK (-RAL 9005)
- HARMAA / GREY (-RAL 9006)



VALOVIRRRAN YLLÄPITO / LIFETIME 55 000H (L80 B10)  
MATERIAALI / MATERIAL RUNKO PULVERIMAALATTUA ALUMIINIA / POWDER PAINTED ALUMINIUM  
ASENNUS / INSTALLATION KISKOKIINNITYS / TRACK MOUNTED



### Valaisin (LOR90%), netto

Teho W	Virra mA	2700K CRI90 CITILED COB Series Version3 CLU030-1206E1-272HSY2	3000K CRI90 Fortimo SLM C 930 P/W 1208 L15 2024 G7 HE+	3500K CRI90 Fortimo SLM C 935 P/W 1208 L15 2024 G7 HE+	4000K CRI90 Fortimo SLM C 940 P/W 1208 L15 2024 G7 HE	Meat CITILED COB Series CLU038-1208C4-205HHK4	Bakery CITILED COB Series CLU038-1208C4-244HJK4
29	650	2963	3073	3171	3070	1626	1918
31	700	3191	3310	3415	3306	1751	2065
33	750	3419	3546	3659	3542	1876	2213
35	800	3647	3782	3903	3778	2001	2361
36	850	3875	4019	4147	4014	2126	2508
38	900	4103	4255	4391	4250	2251	2656
40	950	4331	4492	4635	4487	2376	2803
42	1000	4559	4728	4879	4723	2501	2951
44	1050	4787	4964	5123	4959	2626	3098

COB1206

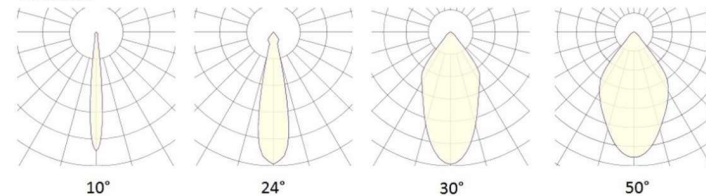

COB1212

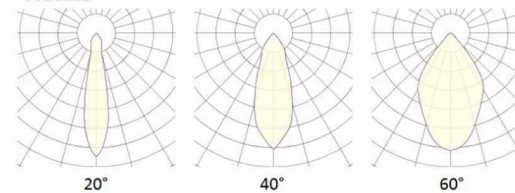

# GA ZENITH

## TEKNISET TIEDOT / TECHNICAL INFORMATION

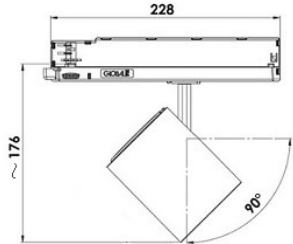

ON-OFF / DALI / CASAMBI / TRIAC  
5 VUODEN TAKUU / 5 YEARS WARRANTY  
MACADAMS 2 SDCM

- VALKOINEN / WHITE (-RAL 9016)
- MUSTA / BLACK (-RAL 9005)
- HARMAA / GREY (-RAL 9006)



VALOVIRRAN YLLÄPITO / LIFETIME 55 000H (L80 B10)  
MATERIAALI / MATERIAL RUNKO PULVERIMAALATTUA ALUMIINIA / POWDER PAINTED ALUMINUM  
ASENNUS / INSTALLATION KISKOKIINNITYS / TRACK MOUNTED



Valaisin (LOR90%), netto							
Teho	Virta	2700K CRI90	3000K CRI90	3500K CRI90	4000K CRI90	Meat	Bakery
W	mA	CITILED COB Series Version3 CLU03Q-1208E1-27ZHSY2	Fortimo SLM C 930 P/W 1208 L15 2024 G7 HE+	Fortimo SLM C 935 P/W 1208 L15 2024 G7 HE+	Fortimo SLM C 940 P/W 1208 L15 2024 G7 HE	CITILED COB Series CLU038-1208C4-205HHK4	CITILED COB Series CLU038-1208C4-244HK4
15	350	1596	1655	1708	1653	875	1033
18	400	1823	1891	1951	1889	1001	1180
20	450	2051	2128	2195	2125	1126	1328
22	500	2279	2364	2439	2361	1251	1475
24	550	2507	2600	2683	2597	1376	1623
27	600	2735	2837	2927	2834	1501	1770
29	650	2963	3073	3171	3070	1626	1918
31	700	3191	3310	3415	3306	1751	2065
33	750	3419	3546	3659	3542	1876	2213
35	800	3647	3782	3903	3778	2001	2361
36	850	3875	4019	4147	4014	2126	2508

### Valonjakokäyrä

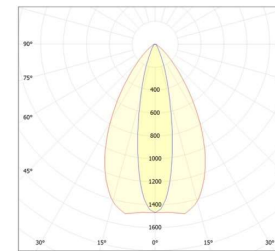

30°

### Kartiokaavio

Cone Diagram (850mA, 930 PW HE) :

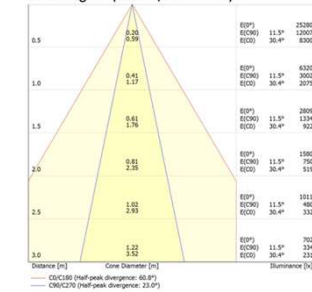



## TEKNISET TIEDOT / TECHNICAL INFORMATION

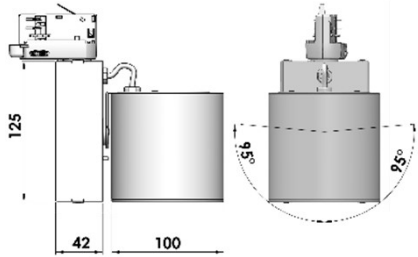

ON-OFF / DALI / CASAMBI / TRIAC  
5 VUODEN TAKUU / 5 YEARS WARRANTY  
MACADAMS 2 SDCM

- VALKOINEN / WHITE (-RAL 9016)  
 MUSTA / BLACK (-RAL 9005)  
 HARMAA / GREY (-RAL 9006)



VALOVIRRRAN YLLÄPITO / LIFETIME 55 000H (L80 B10)  
MATERIAALI / MATERIAL RUNKO PULVERIMAALATTUA ALUMIINIA / POWDER PAINTED ALUMINIUM  
ASENNUS / INSTALLATION KISKOKIINNITYS / TRACK MOUNTED



## Valaisin (LOR90%), netto

Teho W	Virta mA	CRI90				Meat		Bakery
		2700K CRI90 CITILED COB Series Version3 CLU030Q-1206E1-27ZHSY2	3000K CRI90 Fortimo SLM C 930 Pw/ 1208 L15 2024 G7 HE+	3500K CRI90 Fortimo SLM C 935 Pw/ 1208 L15 2024 G7 HE+	4000K CRI90 Fortimo SLM C 940 Pw/ 1208 L15 2024 G7 HE	CITILED COB Series CLU038-1208C4-205HHK4	CITILED COB Series CLU038-1208C4-244HJK4	
20	450	2051	2128	2195	2125	1126	1328	
22	500	2279	2364	2439	2361	1251	1475	
24	550	2507	2600	2683	2597	1376	1623	
27	600	2735	2837	2927	2834	1501	1770	
29	650	2963	3073	3171	3070	1626	1918	
31	700	3191	3310	3415	3306	1751	2065	
33	750	3419	3546	3659	3542	1876	2213	
35	800	3647	3782	3903	3778	2001	2361	
36	850	3875	4019	4147	4014	2126	2508	
38	900	4103	4255	4391	4250	2251	2656	
40	950	4331	4492	4635	4487	2376	2803	
42	1000	4559	4728	4879	4723	2501	2951	
44	1050	4787	4964	5123	4959	2626	3098	

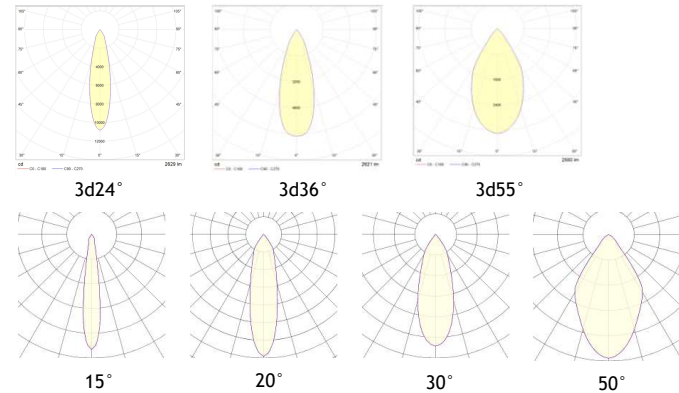

## TEKNISET TIEDOT / TECHNICAL INFORMATION

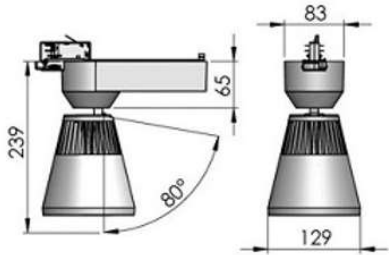

ON-OFF / DALI / CASAMBI / TRIAC  
5 VUODEN TAKUU / 5 YEARS WARRANTY  
MACADAMS 2 SDCM

- VALKOINEN / WHITE (-RAL 9016)  
 MUSTA / BLACK (-RAL 9005)  
 HARMAA / GREY (-RAL 9006)



VALOVIRRRAN YLLÄPITO / LIFETIME 55 000H (L80 B10)  
MATERIAALI / MATERIAL RUNKO PULVERIMAALATTUUA ALUMINIINIA / POWDER PAINTED ALUMINIUM  
ASENNUS / INSTALLATION KISKOKIINNITYS / TRACK MOUNTED



Valaisin (LOR90%), netto								
Teho W	Virta mA	2700K CRI90 CITILED COB Series Version3 CLU03Q-1206E1-272HSY2	3000K CRI90 Fortimo SLMC 930 P/W 1208 L15 2024 G7 HE+	3500K CRI90 Fortimo SLMC 935 P/W 1208 L15 2024 G7 HE+	4000K CRI90 Fortimo SLMC 940 P/W 1208 L15 2024 G7 HE	Meat CITILED COB Series CLU038-1208C4-205HHK4	Bakery CITILED COB Series CLU038-1208C4-244HJK4	
29	650	2963	3073	3171	3070	1626	1918	
31	700	3191	3310	3415	3306	1751	2065	
33	750	3419	3546	3659	3542	1876	2213	
35	800	3647	3782	3903	3778	2001	2361	
36	850	3875	4019	4147	4014	2126	2508	
38	900	4103	4255	4391	4250	2251	2656	
40	950	4331	4492	4635	4487	2376	2803	
42	1000	4559	4728	4879	4723	2501	2951	
44	1050	4787	4964	5123	4959	2626	3098	
53	1200	5470	5674	5854	5667	3002	3541	

COB1206

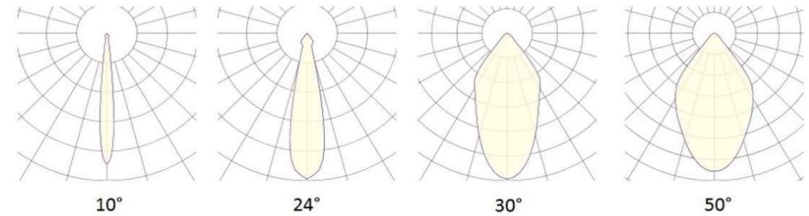

COB1212

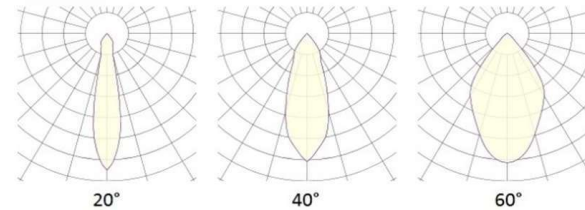



## TEKNISET TIEDOT / TECHNICAL INFORMATION

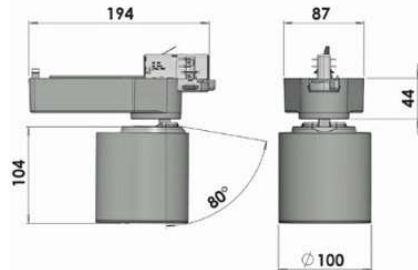

ON-OFF / DALI / CASAMBI / TRIAC  
5 VUODEN TAKUU / 5 YEARS WARRANTY  
MACADAMS 2 SDCM

- VALKOINEN / WHITE (-RAL 9016)  
 MUSTA / BLACK (-RAL 9005)  
 HARMAA / GREY (-RAL 9006)



VALOVIRRRAN YLLÄPITO / LIFETIME 55 000H (L80 B10)  
MATERIAALI / MATERIAL RUNKO PULVERIMAALATTU ALUMIINIA / POWDER PAINTED ALUMINIUM  
ASENNUS / INSTALLATION KISKOKIINNITYS / TRACK MOUNTED



## Valaisin (LOR90%), netto

Teho W	Virta mA	2700K CRI90	3000K CRI90	3500K CRI90	4000K CRI90	Meat	Bakery
		CITILED COB Series Version3 CLU030Q-1206E1-27ZHSY2	Fortimo SLM C 930 Pw/ 1208 L15 2024 G7 HE+	Fortimo SLM C 935 Pw/ 1208 L15 2024 G7 HE+	Fortimo SLM C 940 Pw/ 1208 L15 2024 G7 HE	CITILED COB Series CLU038-1208C4-205HHK4	CITILED COB Series CLU038-1208C4-244HJK4
20	450	2051	2128	2195	2125	1126	1328
22	500	2279	2364	2439	2361	1251	1475
24	550	2507	2600	2683	2597	1376	1623
27	600	2735	2837	2927	2834	1501	1770
29	650	2963	3073	3171	3070	1626	1918
31	700	3191	3310	3415	3306	1751	2065
33	750	3419	3546	3659	3542	1876	2213
35	800	3647	3782	3903	3778	2001	2361
36	850	3875	4019	4147	4014	2126	2508
38	900	4103	4255	4391	4250	2251	2656
40	950	4331	4492	4635	4487	2376	2803
42	1000	4559	4728	4879	4723	2501	2951
44	1050	4787	4964	5123	4959	2626	3098

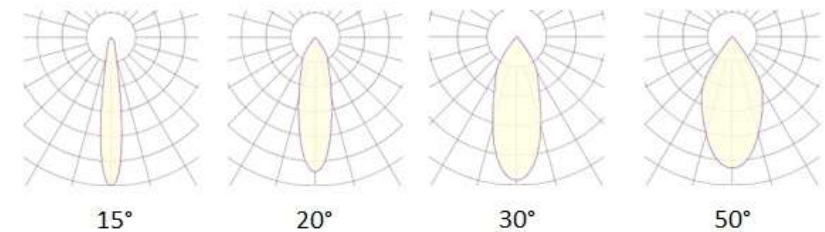



## TEKNISET TIEDOT / TECHNICAL INFORMATION

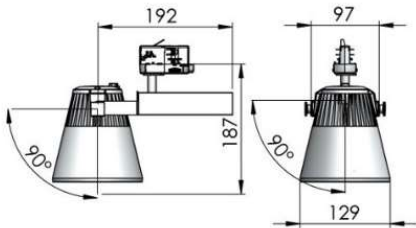

ON-OFF / DALI / CASAMBI / TRIAC  
5 VUODEN TAKUU / 5 YEARS WARRANTY  
MACADAMS 2 SDCM

- VALKOINEN / WHITE (-RAL 9016)
- MUSTA / BLACK (-RAL 9005)
- HARMAA / GREY (-RAL 9006)



VALOVIRRRAN YLLÄPITO / LIFETIME 55 000H (L80 B10)  
MATERIAALI / MATERIAL RUNKO PULVERIMAALATTUA ALUMIINIA / POWDER PAINTED ALUMINIUM  
ASENNUS / INSTALLATION KISKOKIINNITYS / TRACK MOUNTED

## Valaisin (LOR90%), netto

Teho W	Virta mA	2700K CRI90	3000K CRI90	3500K CRI90	4000K CRI90	Meat	Bakery
		CITILED COB Series Version3 CLU03Q-1208E1-272HSY2	Fortimo SLM C 330 P/W 1208 L15 2024 G7 HE+	Fortimo SLM C 335 P/W 1208 L15 2024 G7 HE+	Fortimo SLM C 340 P/W 1208 L15 2024 G7 HE	CITILED COB Series CLU038-1208C4-205HHK4	CITILED COB Series CLU038-1208C4-244HJK4
29	650	2963	3073	3171	3070	1626	1918
31	700	3191	3310	3415	3306	1751	2065
33	750	3419	3546	3659	3542	1876	2213
35	800	3647	3782	3903	3778	2001	2361
36	850	3875	4019	4147	4014	2126	2508
38	900	4103	4255	4391	4250	2251	2656
40	950	4331	4492	4635	4487	2376	2803
42	1000	4559	4728	4879	4723	2501	2951
44	1050	4787	4964	5123	4959	2626	3098
53	1200	5470	5674	5854	5667	3002	3541



COB1206

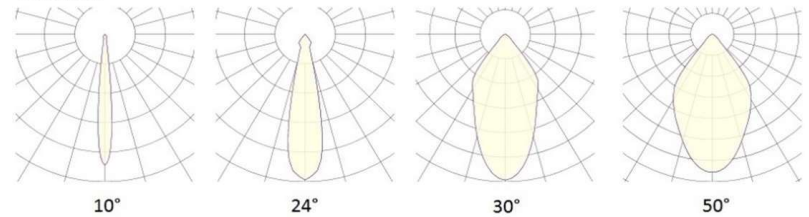

COB1212

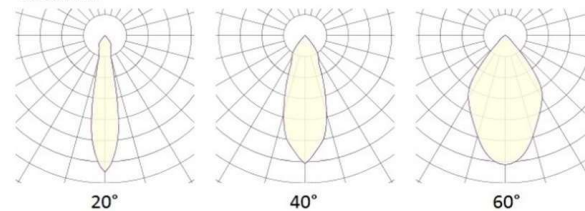

# HOHDE S

## TEKNISET TIEDOT / TECHNICAL INFORMATION

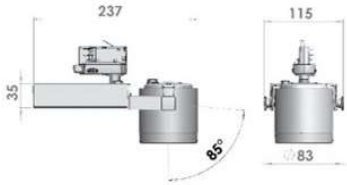

ON-OFF / DALI / CASAMBI / TRIAC  
5 VUODEN TAKUU / 5 YEARS WARRANTY  
MACADAMS 2 SDCM

- VALKOINEN / WHITE (-RAL 9016)
- MUSTA / BLACK (-RAL 9005)
- HARMAA / GREY (-RAL 9006)



VALOVIRRRAN YLLÄPITO / LIFETIME 55 000H (L80 B10)  
MATERIAALI / MATERIAL RUNKO PULVERIMAALATTUA ALUMIINIA / POWDER PAINTED ALUMINUM  
ASENNUS / INSTALLATION KISKOKIIINNITYS / TRACK MOUNTED



Valaisin (LOR90%), netto							
Teho W	Virta mA	2700K CRI90 CITILED COB Series Version3 CLU03Q-1206E1-272HSY2	3000K CRI90 Fortimo SLM C 930 PW 1208 L15 2024 G7 HE+	3500K CRI90 Fortimo SLM C 935 PW 1208 L15 2024 G7 HE+	4000K CRI90 Fortimo SLM C 940 PW 1208 L15 2024 G7 HE	Meat CITILED COB Series CLU038-1208C4-205HHK4	Bakery CITILED COB Series CLU038-1208C4-244HJK4
20	450	2051	2128	2195	2125	1126	1328
22	500	2279	2364	2439	2361	1251	1475
24	550	2507	2600	2683	2597	1376	1623
27	600	2735	2837	2927	2834	1501	1770
29	650	2963	3073	3171	3070	1626	1918
31	700	3191	3310	3415	3306	1751	2065
33	750	3419	3546	3659	3542	1876	2213
35	800	3647	3782	3903	3778	2001	2361
36	850	3875	4019	4147	4014	2126	2508
38	900	4103	4255	4391	4250	2251	2656

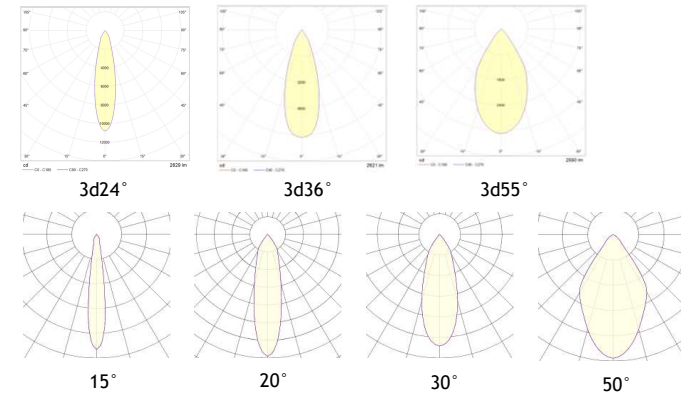

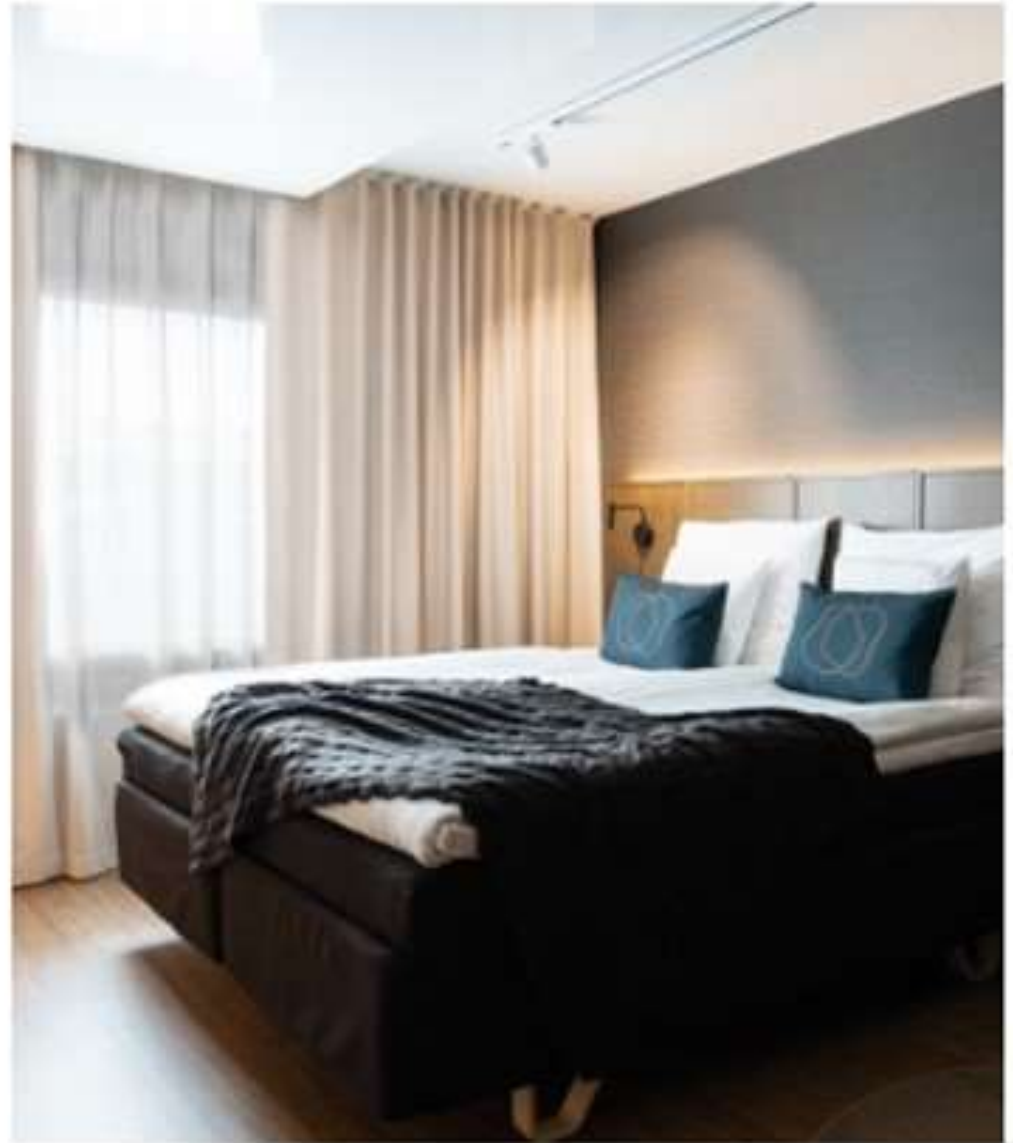

# KIMMEL B



## TEKNISET TIEDOT / TECHNICAL INFORMATION

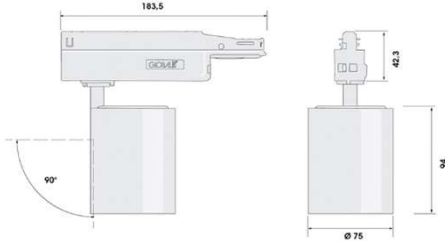

ON-OFF / DALI / CASAMBI / TRIAC  
5 VUODEN TAKUU / 5 YEARS WARRANTY  
MACADAMS 2 SDCM

- VALKOINEN / WHITE (-RAL 9016)
- MUSTA / BLACK (-RAL 9005)
- HARMAA / GREY (-RAL 9006)



VALOVIRRRAN YLLÄPITO / LIFETIME 55 000H (L80 B10)  
MATERIAALI / MATERIAL RUNKO PULVERIMAALATTUA ALUMIINIA / POWDER PAINTED ALUMINUM  
ASENNUS / INSTALLATION 1-VAIHE KISKOKIINNITYS / 1-PHASE TRACK MOUNTED



### Valaisin (LOR90%), netto

Teho W	Virta mA	2700K CRI90		3000K CRI90		3500K CRI90		4000K CRI90		Meat	Bakery
		CITILED COB Series Version3 CLU030Q-1206E1-272HSY2	Fortimo SLM C 930 Pw/ 1208 L15 2024 G7 HE+	Fortimo SLM C 930 Pw/ 1208 L15 2024 G7 HE+	Fortimo SLM C 935 Pw/ 1208 L15 2024 G7 HE+	Fortimo SLM C 940 Pw/ 1208 L15 2024 G7 HE	CITILED COB Series CLU038-1208C4-20SHHK4	CITILED COB Series CLU038-1208C4-244HJK4			
13	300	1368	1418	1464	1417	750	885				
15	350	1596	1655	1708	1653	875	1033				
18	400	1823	1891	1951	1889	1001	1180				
20	450	2051	2128	2195	2125	1126	1328				
22	500	2279	2364	2439	2361	1251	1475				
24	550	2507	2600	2683	2597	1376	1623				
27	600	2735	2837	2927	2834	1501	1770				
29	650	2963	3073	3171	3070	1626	1918				
31	700	3191	3310	3415	3306	1751	2065				
33	750	3419	3546	3659	3542	1876	2213				

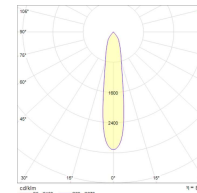

3D15°

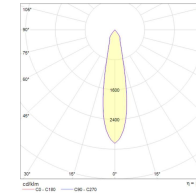

3D21°

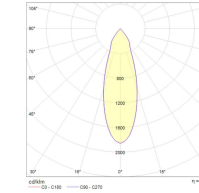

3D32°

# LUMI B



## TEKNISET TIEDOT / TECHNICAL INFORMATION

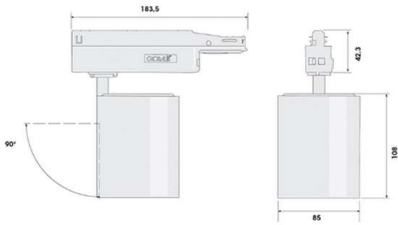

ON-OFF / DALI / CASAMBI / TRIAC  
5 VUODEN TAKUU / 5 YEARS WARRANTY  
MACADAMS 2 SDCM

- VALKOINEN / WHITE (-RAL 9016)
- MUSTA / BLACK (-RAL 9005)
- HARMAA / GREY (-RAL 9006)



VALOVIRRRAN YLLÄPITO / LIFETIME 55 000H (L80 B10)  
MATERIAALI / MATERIAL RUNKO PULVERIMAALATTUA ALUMIINIA / POWDER PAINTED ALUMINUM  
ASENNUS / INSTALLATION 1-VAIHE KISKOKIINNITYS / 1-PHASE TRACK MOUNTED

Valaisin (LOR90%), netto							
Teho	Virta	2700K CRI90	3000K CRI90	3500K CRI90	4000K CRI90	Meat	Bakery
W	mA	CITILED COB Series Version3 CLU003Q-1206E1-27ZHSY2	Fortimo SLM C 930 Pw/ 1208 L15 2024 G7 HE+	Fortimo SLM C 935 Pw/ 1208 L15 2024 G7 HE+	Fortimo SLM C 940 Pw/ 1208 L15 2024 G7 HE+	CITILED COB Series CLU038-1208C4-205HKK4	CITILED COB Series CLU038-1208C4-244HJK4
13	300	1368	1418	1464	1417	750	885
15	350	1596	1655	1708	1653	875	1033
18	400	1823	1891	1951	1889	1001	1180
20	450	2051	2128	2195	2125	1126	1328
22	500	2279	2364	2439	2361	1251	1475
24	550	2507	2600	2683	2597	1376	1623
27	600	2735	2837	2927	2834	1501	1770
29	650	2963	3073	3171	3070	1626	1918
31	700	3191	3310	3415	3306	1751	2065
33	750	3419	3546	3659	3542	1876	2213
35	800	3647	3782	3903	3778	2001	2361
36	850	3875	4019	4147	4014	2126	2508

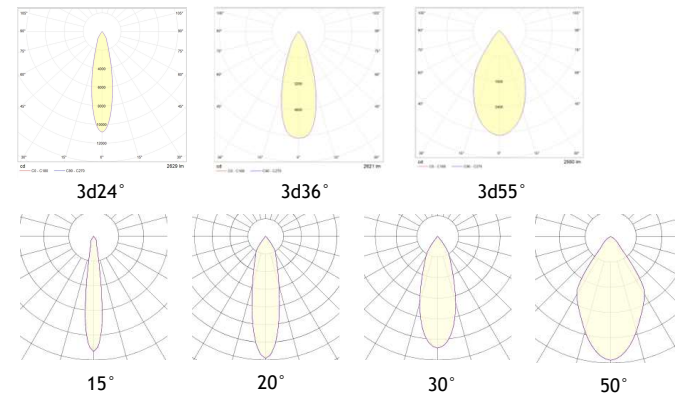

# FOCUS B



## TEKNISET TIEDOT / TECHNICAL INFORMATION

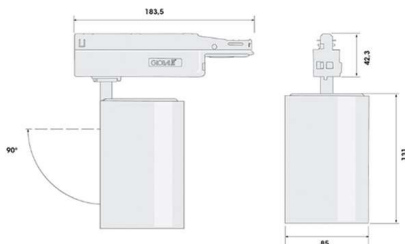

ON-OFF / DALI / CASAMBI / TRIAC  
5 VUODEN TAKUU / 5 YEARS WARRANTY  
MACADAMS 2 SDCM

- VALKOINEN / WHITE (-RAL 9016)
- MUSTA / BLACK (-RAL 9005)
- HARMAA / GREY (-RAL 9006)



VALOVIRRRAN YLLÄPITO / LIFETIME 55 000H (L80 B10)  
MATERIAALI / MATERIAL RUNKO PULVERIMAALATTUA ALUMIINIA / POWDER PAINTED ALUMINUM  
ASENNUS / INSTALLATION 1-VAIHE KISKOKIINNITYS / 1-PHASE TRACK MOUNTED



### Valaisin (LOR90%), netto

Teho W	Virta mA	2700K CRI90 CITILED COB Series Version3 CLU030-1208E1-272HSY2	3000K CRI90 Fortimo SLM C 930 Pw/ 1208 L15 2024 G7 HE+	3500K CRI90 Fortimo SLM C 935 Pw/ 1208 L15 2024 G7 HE+	4000K CRI90 Fortimo SLM C 940 Pw/ 1208 L15 2024 G7 HE	Meat CITILED COB Series CLU038-1208C4-205HKK4	Bakery CITILED COB Series CLU038-1208C4-244HJK4
13	300	1368	1418	1464	1417	750	885
15	350	1596	1655	1708	1653	875	1033
18	400	1823	1891	1951	1889	1001	1180
20	450	2051	2128	2195	2125	1126	1328
22	500	2279	2364	2439	2361	1251	1475
24	550	2507	2600	2683	2597	1376	1623
27	600	2735	2837	2927	2834	1501	1770
29	650	2963	3073	3171	3070	1626	1918
31	700	3191	3310	3415	3306	1751	2065
33	750	3419	3546	3659	3542	1876	2213
35	800	3647	3782	3903	3778	2001	2361
36	850	3875	4019	4147	4014	2126	2508
38	900	4103	4255	4391	4250	2251	2656
40	950	4331	4492	4635	4487	2376	2803
42	1000	4559	4728	4879	4723	2501	2951
44	1050	4787	4964	5123	4959	2626	3098

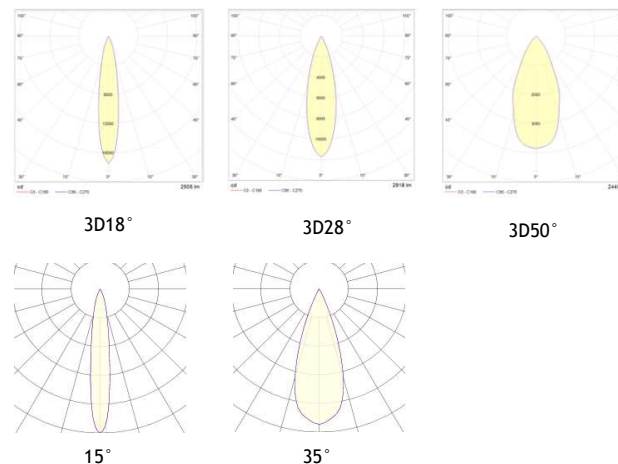

# FOCUS B PENDANT

TEKNISET TIEDOT / TECHNICAL INFORMATION

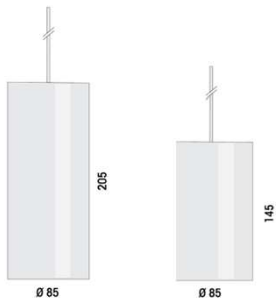

ON-OFF / DALI / CASAMBI / TRIAC  
5 VUODEN TAKUU / 5 YEARS WARRANTY  
MACADAMS 2 SDCM

- VALKOINEN / WHITE (-RAL 9016)
- MUSTA / BLACK (-RAL 9005)
- HARMAA / GREY (-RAL 9006)



VALOVIRRRAN YLLÄPITO / LIFETIME 55 000H (L80 B10)  
MATERIAALI / MATERIAL RUNKO PULVERIMAALATTUA ALUMIINIA / POWDER PAINTED ALUMINUM  
ASENNUS / INSTALLATION ROIKKUASENNUS 1-VAIHEKISKOON / CEILING SUSPENDED 1-PHASE TRACK



Valaisin (LOR90%), netto							
Teho W	Virta mA	2700K CRI90 CITILED COB Series Version3 CLU030Q-1208E1-272HSY2	3000K CRI90 Fortimo SLMC 930 P/W 1208 L15 2024 G7 HE+	3500K CRI90 Fortimo SLMC 935 P/W 1208 L15 2024 G7 HE+	4000K CRI90 Fortimo SLMC 940 P/W 1208 L15 2024 G7 HE	Meat CITILED COB Series CLU038-1208C4-205HHK4	Bakery CITILED COB Series CLU036-1208C4-244HK4
13	300	1368	1418	1464	1417	750	885
15	350	1596	1655	1708	1653	875	1033
18	400	1823	1891	1951	1889	1001	1180
20	450	2051	2128	2195	2125	1126	1328
22	500	2279	2364	2439	2361	1251	1475
24	550	2507	2600	2683	2597	1376	1623
27	600	2735	2837	2927	2834	1501	1770
29	650	2963	3073	3171	3070	1626	1918
31	700	3191	3310	3415	3306	1751	2065
33	750	3419	3546	3659	3542	1876	2213
35	800	3647	3782	3903	3778	2001	2361
36	850	3875	4019	4147	4014	2126	2508

\*145 cm versio 750mA saakka / 145cm lighting fixture until 750 mA

Valonjakokäyrät 3D

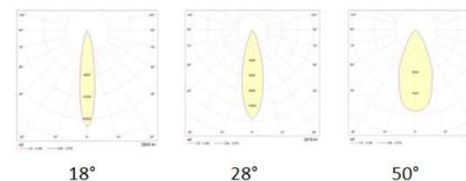

Valonjakokäyrät

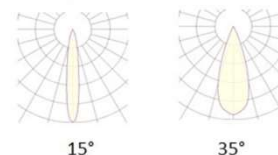





# AURA DL

## TEKNISET TIEDOT / TECHNICAL INFORMATION

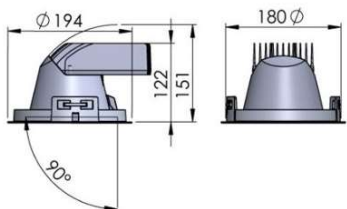

ON-OFF / DALI / CASAMBI / TRIAC  
 5 VUODEN TAKUU / 5 YEARS WARRANTY  
 MACADAMS 2 SDCM

- VALKOINEN / WHITE (-RAL 9016)
- MUSTA / BLACK (-RAL 9005)
- HARMAA / GREY (-RAL 9006)



VALOVIRRRAN YLLÄPITO / LIFETIME 55 000H (L80 B10)  
 MATERIAALI / MATERIAL RUNKO PULVERIMAALATTUA ALUMIINIA / POWDER PAINTED ALUMINUM  
 ASENNUS / INSTALLATION UPOASENNUS / RECESSED



### Valaisin (LOR90%), netto

Teho W	Virta mA	2700K CRI90 CITILED COB Series Version3 CLU030-1208E1-272H5Y2	3000K CRI90 Fortimo SLMC 330 PW 1208 L15 2024 G7 HE+	3500K CRI90 Fortimo SLMC 335 PW 1208 L15 2024 G7 HE+	4000K CRI90 Fortimo SLMC 340 PW 1208 L15 2024 G7 HE	Meat CITILED COB Series CLU038-1208C4-205H4K4	Bakery CITILED COB Series CLU038-1208C4-244H4K4
15	350	1596	1655	1708	1653	875	1033
18	400	1823	1891	1951	1889	1001	1180
20	450	2051	2128	2195	2125	1126	1328
22	500	2279	2364	2439	2361	1251	1475
24	550	2507	2600	2683	2597	1376	1623
27	600	2735	2837	2927	2834	1501	1770
29	650	2963	3073	3171	3070	1626	1918
31	700	3191	3310	3415	3306	1751	2065
33	750	3419	3546	3659	3542	1876	2213
35	800	3647	3782	3903	3778	2001	2361
36	850	3875	4019	4147	4014	2126	2508
38	900	4103	4255	4391	4250	2251	2656
40	950	4331	4492	4635	4487	2376	2803
42	1000	4559	4728	4879	4723	2501	2951
44	1050	4787	4964	5123	4959	2626	3098
53	1200	5470	5674	5854	5667	3002	3541

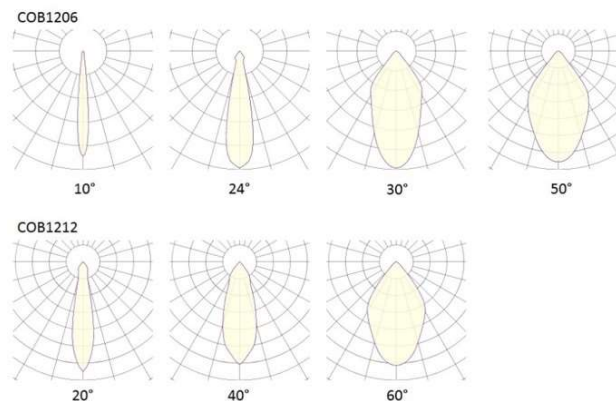

# AURA S DL



TEKNISET TIEDOT / TECHNICAL INFORMATION

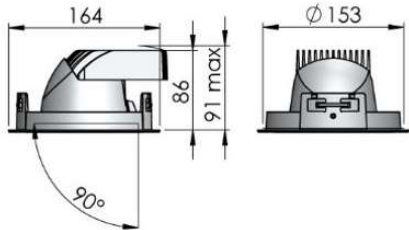

ON-OFF / DALI / CASAMBI / TRIAC  
 5 VUODEN TAKUU / 5 YEARS WARRANTY  
 MACADAMS 2 SDCM

- VALKOINEN / WHITE (-RAL 9016)
- MUSTA / BLACK (-RAL 9005)
- HARMAA / GREY (-RAL 9006)



VALOVIRRRAN YLLÄPITO / LIFETIME 55 000H (L80 B10)  
 MATERIAALI / MATERIAL RUNKO PULVERIMAALATTUA ALUMIINIA / POWDER PAINTED ALUMINUM  
 ASENNUS / INSTALLATION UPPOASENNUS / RECESSED



Valaisin (LOR90%), netto							
Teho W	Virta mA	2700K CRI90 <small>CITILED COB Series Version3 CLU03Q-1206E1-272HSY2</small>	3000K CRI90 <small>Fortimo SLM C 930 P/W 1208 L15 2024 G7 HE+</small>	3500K CRI90 <small>Fortimo SLM C 935 P/W 1208 L15 2024 G7 HE+</small>	4000K CRI90 <small>Fortimo SLM C 940 P/W 1208 L15 2024 G7 HE</small>	Meat <small>CITILED COB Series CLU038-1208C4-205HHK4</small>	Bakery <small>CITILED COB Series CLU038-1208C4-244HK4</small>
13	300	1368	1418	1464	1417	750	885
15	350	1596	1655	1708	1653	875	1033
18	400	1823	1891	1951	1889	1001	1180
20	450	2051	2128	2195	2125	1126	1328
22	500	2279	2364	2439	2361	1251	1475
24	550	2507	2600	2683	2597	1376	1623
27	600	2735	2837	2927	2834	1501	1770
29	650	2963	3073	3171	3070	1626	1918
31	700	3191	3310	3415	3306	1751	2065
33	750	3419	3546	3659	3542	1876	2213
35	800	3647	3782	3903	3778	2001	2361
36	850	3875	4019	4147	4014	2126	2508
38	900	4103	4255	4391	4250	2251	2656
40	950	4331	4492	4635	4487	2376	2803
42	1000	4559	4728	4879	4723	2501	2951
44	1050	4787	4964	5123	4959	2626	3098

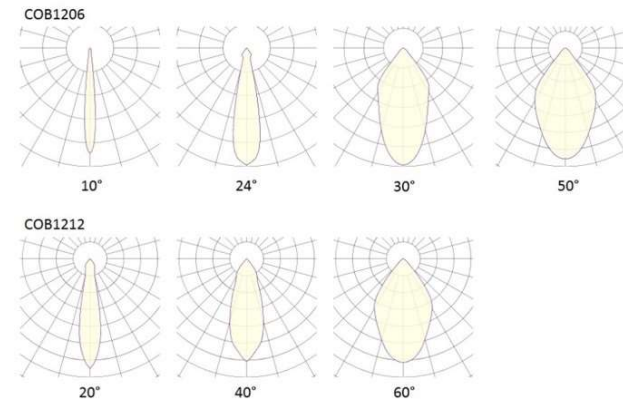

# TAIKA DL



## TEKNISET TIEDOT / TECHNICAL INFORMATION

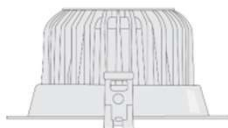
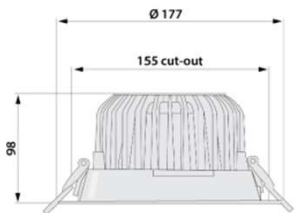

ON-OFF / DALI / CASAMBI / TRIAC  
5 VUODEN TAKUU / 5 YEARS WARRANTY  
MACADAMS 2 SDCM

- VALKOINEN / WHITE (-RAL 9016)
- MUSTA / BLACK (-RAL 9005)
- HARMAA / GREY (-RAL 9006)



VALOVIIRAN YLLÄPITO / LIFETIME 55 000H (L80 B10)  
MATERIAALI / MATERIAL RUNKO PULVERIMAALATTUA ALUMIINIA / POWDER PAINTED ALUMINUM  
ASENNUS / INSTALLATION UPPOASENNUS / RECESSED



Valaisin (LOR90%), netto							
Teho W	Virta mA	2700K CRI90 CITILED COB Series Version3 CLU03Q-1208E1+272HSY2	3000K CRI90 Fortimo SLM C 930 PW 1208 L15 2024 G7 HE+	3500K CRI90 Fortimo SLM C 935 PW 1208 L15 2024 G7 HE+	4000K CRI90 Fortimo SLM C 940 PW 1208 L15 2024 G7 HE	Meat CITILED COB Series CLU038-1208C4-205HHK4	Bakery CITILED COB Series CLU038-1208C4-244HK4
13	300	1368	1418	1464	1417	750	885
15	350	1596	1655	1708	1653	875	1033
18	400	1823	1891	1951	1889	1001	1180
20	450	2051	2128	2195	2125	1126	1328
22	500	2279	2364	2439	2361	1251	1475
24	550	2507	2600	2683	2597	1376	1623
27	600	2735	2837	2927	2834	1501	1770
29	650	2963	3073	3171	3070	1626	1918
31	700	3191	3310	3415	3306	1751	2065
33	750	3419	3546	3659	3542	1876	2213
35	800	3647	3782	3903	3778	2001	2361
36	850	3875	4019	4147	4014	2126	2508
38	900	4103	4255	4391	4250	2251	2656
40	950	4331	4492	4635	4487	2376	2803
42	1000	4559	4728	4879	4723	2501	2951
44	1050	4787	4964	5123	4959	2626	3098
53	1200	5470	5674	5854	5667	3002	3541

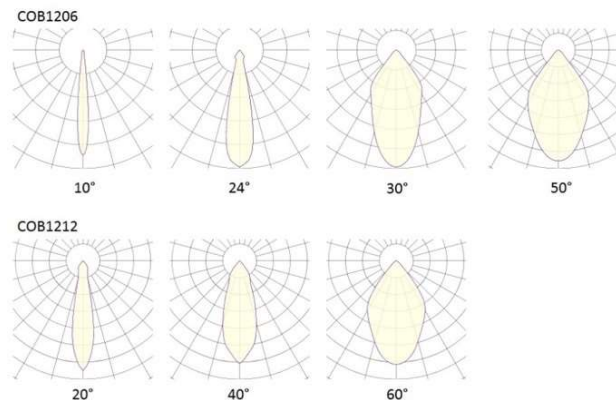

# FOCUS DL



## TEKNISET TIEDOT / TECHNICAL INFORMATIONS

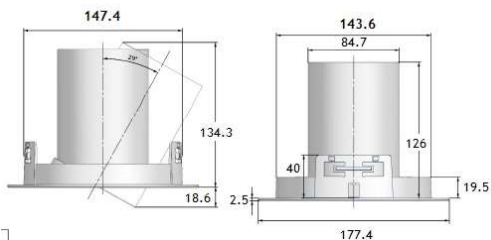

ON-OFF / DALI / CASAMBI / TRIAC  
5 VUODEN TAKUU / 5 YEARS WARRANTY  
MACADAMS 2 SDCM

- VALKOINEN / WHITE (-RAL 9016)
- MUSTA / BLACK (-RAL 9005)
- HARMAA / GREY (-RAL 9006)



VALOVIRRRAN YLLÄPITO / LIFETIME 55 000H (L80 B10)  
MATERIAALI / MATERIAL RUNKO PULVERIMAALATTUA ALUMIINIA / POWDER PAINTED ALUMINIUM  
ASENNUS / INSTALLATION UPOASENNUS / RECESSED



Valaisin (LOR90%), netto							
Teho W	Virta mA	2700K CRI90 <small>CITILED COB Series Version3 CLU03Q-1206E1-272HSY2</small>	3000K CRI90 <small>Fortimo SLM C 930 Pw/ 1208 L15 2024 G7 HE+</small>	3500K CRI90 <small>Fortimo SLM C 935 Pw/ 1208 L15 2024 G7 HE+</small>	4000K CRI90 <small>Fortimo SLM C 940 Pw/ 1208 L15 2024 G7 HE</small>	Meat <small>CITILED COB Series CLU038-1208C4-205HKK4</small>	Bakery <small>CITILED COB Series CLU038-1208C4-244HJK4</small>
24	550	2507	2600	2683	2597	1376	1623
27	600	2735	2837	2927	2834	1501	1770
29	650	2963	3073	3171	3070	1626	1918
31	700	3191	3310	3415	3306	1751	2065
33	750	3419	3546	3659	3542	1876	2213
35	800	3647	3782	3903	3778	2001	2361
36	850	3875	4019	4147	4014	2126	2508

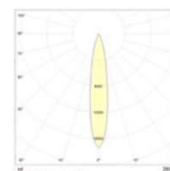

3d 18°

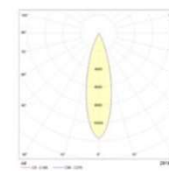

3d 28°

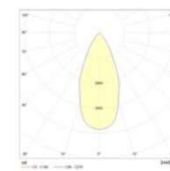

3d 50°

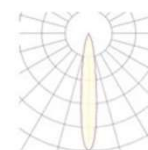

15°

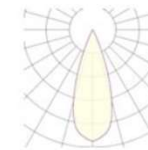

35°

# VIVID S DL



TEKNISET TIEDOT / TECHNICAL INFORMATION

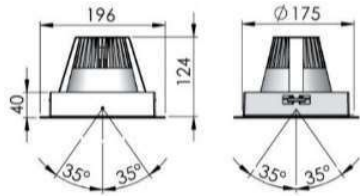

ON-OFF / DALI / CASAMBI / TRIAC  
 5 VUODEN TAKUU / 5 YEARS WARRANTY  
 MACADAMS 2 SDCM

- VALKOINEN / WHITE (-RAL 9016)
- MUSTA / BLACK (-RAL 9005)
- HARMAA / GREY (-RAL 9006)



VALOVIRRRAN YLLÄPITO / LIFETIME 55 000H (L80 B10)  
 MATERIAALI / MATERIAL RUNKO PULVERIMAALATTUA ALUMIINIA / POWDER PAINTED ALUMINUM  
 ASENNUS / INSTALLATION UPPOASENNUS / RECESSED



Valaisin (LOR90%), netto							
Teho W	Virta mA	2700K CRI90 <small>CITILED COB Series Version3 CLU03Q-1206E1-272H5V2</small>	3000K CRI90 <small>Fortimo SLM C 930 Pw 1208 L15 2024 G7 HE+</small>	3500K CRI90 <small>Fortimo SLM C 935 Pw 1208 L15 2024 G7 HE+</small>	4000K CRI90 <small>Fortimo SLM C 940 Pw 1208 L15 2024 G7 HE</small>	Meat <small>CITILED COB Series CLU03B-1208C4-205H4K4</small>	Bakery <small>CITILED COB Series CLU03B-1208C4-244H4K4</small>
13	300	1368	1418	1464	1417	750	885
15	350	1596	1655	1708	1653	875	1033
18	400	1823	1891	1951	1889	1001	1180
20	450	2051	2128	2195	2125	1126	1328
22	500	2279	2364	2439	2361	1251	1475
24	550	2507	2600	2683	2597	1376	1623
27	600	2735	2837	2927	2834	1501	1770
29	650	2963	3073	3171	3070	1626	1918
31	700	3191	3310	3415	3306	1751	2065
33	750	3419	3546	3659	3542	1876	2213
35	800	3647	3782	3903	3778	2001	2361
36	850	3875	4019	4147	4014	2126	2508
38	900	4103	4255	4391	4250	2251	2656
40	950	4331	4492	4635	4487	2376	2803
42	1000	4559	4728	4879	4723	2501	2951
44	1050	4787	4964	5123	4959	2626	3098
53	1200	5470	5674	5854	5667	3002	3541

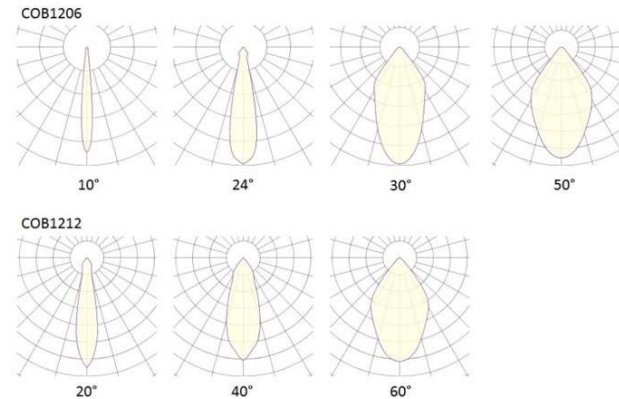

# VIVID DL SERIE

## VIVID C



## VIVID D



## VIVID T

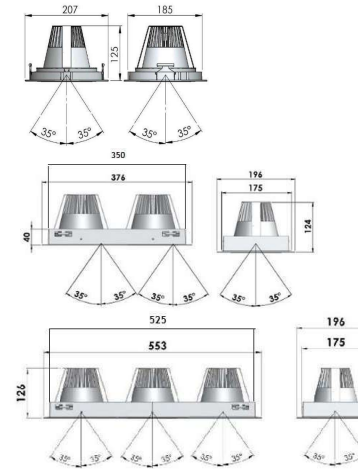

### TEKNISET TIEDOT / TECHNICAL INFORMATIONS

ON-OFF / DALI / CASAMBI / TRIAC  
 5 VUODEN TAKUU / 5 YEARS WARRANTY  
 MACADAMS 2 SDCM

- VALKOINEN / WHITE (-RAL 9016)
- MUSTA / BLACK (-RAL 9005)
- HARMAA / GREY (-RAL 9006)



VALOVIRRRAN YLLÄPITO / LIFETIME 55 000H (L80 B10)  
 MATERIAALI / MATERIAL RUNKO PULVERIMAALATTUA ALUMIINIA / POWDER PAINTED ALUMINIUM  
 ASENNUS / INSTALLATION UPPOASENNUS / RECESSED



Valaisin (LOR90%), netto							
Teho W	Virta mA	2700K CRI90 <small>CITILED COB Series Version3 CLU03Q-1206E1-272H5V2</small>	3000K CRI90 <small>Fortimo SLM C 930 Pw 1208 L15 2024 G7 HE+</small>	3500K CRI90 <small>Fortimo SLM C 935 Pw 1208 L15 2024 G7 HE+</small>	4000K CRI90 <small>Fortimo SLM C 940 Pw 1208 L15 2024 G7 HE</small>	Meat <small>CITILED COB Series CLU038-1208C4-205H+K4</small>	Bakery <small>CITILED COB Series CLU038-1208C4-244HJK4</small>
13	300	1368	1418	1464	1417	750	885
15	350	1596	1655	1708	1653	875	1033
18	400	1823	1891	1951	1889	1001	1180
20	450	2051	2128	2195	2125	1126	1328
22	500	2279	2364	2439	2361	1251	1475
24	550	2507	2600	2683	2597	1376	1623
27	600	2735	2837	2927	2834	1501	1770
29	650	2963	3073	3171	3070	1626	1918
31	700	3191	3310	3415	3306	1751	2065
33	750	3419	3546	3659	3542	1876	2213
35	800	3647	3782	3903	3778	2001	2361
36	850	3875	4019	4147	4014	2126	2508
38	900	4103	4255	4391	4250	2251	2656
40	950	4331	4492	4635	4487	2376	2803
42	1000	4559	4728	4879	4723	2501	2951
44	1050	4787	4964	5123	4959	2626	3098
53	1200	5470	5674	5854	5667	3002	3541

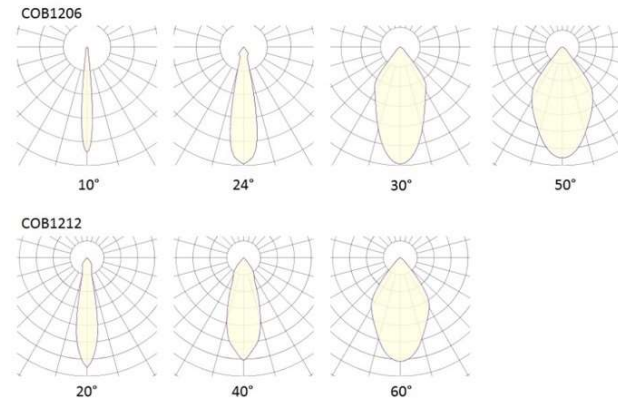

# LOISTE DL

TEKNISET TIEDOT / TECHNICAL INFORMATION

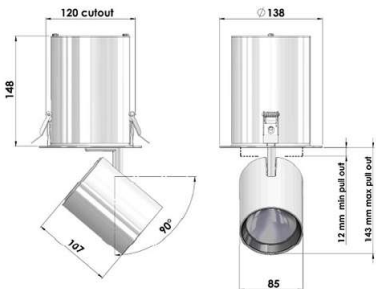

ON-OFF / DALI / CASAMBI / TRIAC  
 5 VUODEN TAKUU / 5 YEARS WARRANTY  
 MACADAMS 2 SDCM

- VALKOINEN / WHITE (-RAL 9016)
- MUSTA / BLACK (-RAL 9005)
- HARMAA / GREY (-RAL 9006)



VALOVIRRRAN YLLÄPITO / LIFETIME 55 000H (L80 B10)  
 MATERIAALI / MATERIAL RUNKO PULVERIMAALATTUA ALUMIINIA / POWDER PAINTED ALUMINUM  
 ASENNUS / INSTALLATION UPOASENNUS / RECESSED



Valaisin (LOR90%), netto							
Teho W	Virta mA	2700K CRI90 CITILED COB Series Version3 CLU03G-1208E1-272HSY2	3000K CRI90 Fortimo SLM C 930 P/W 1208 L15 2024 G7 HE+	3500K CRI90 Fortimo SLM C 935 P/W 1208 L15 2024 G7 HE+	4000K CRI90 Fortimo SLM C 940 P/W 1208 L15 2024 G7 HE	Meat CITILED COB Series CLU038-1208C4-205HHK4	Bakery CITILED COB Series CLU038-1208C4-244HJK4
13	300	1368	1418	1464	1417	750	885
15	350	1596	1655	1708	1653	875	1033
18	400	1823	1891	1951	1889	1001	1180
20	450	2051	2128	2195	2125	1126	1328
22	500	2279	2364	2439	2361	1251	1475
24	550	2507	2600	2683	2597	1376	1623
27	600	2735	2837	2927	2834	1501	1770
29	650	2963	3073	3171	3070	1626	1918
31	700	3191	3310	3415	3306	1751	2065

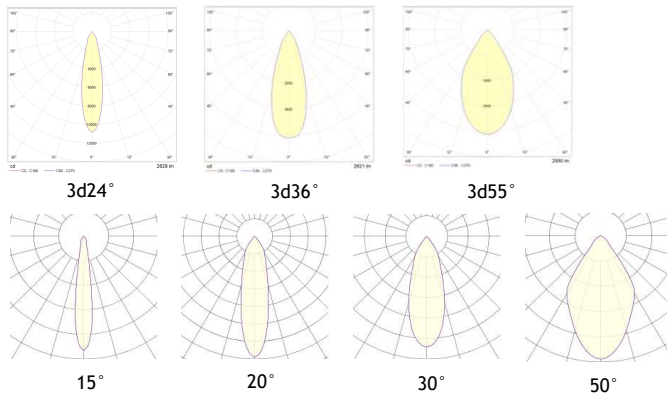



## LUNA S DL

## TEKNISET TIEDOT / TECHNICAL INFORMATION

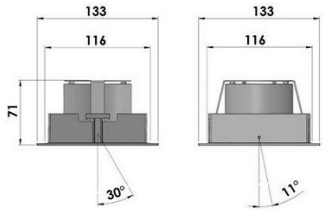

ON-OFF / DALI / CASAMBI / TRIAC  
5 VUODEN TAKUU / 5 YEARS WARRANTY  
MACADAMS 2 SDCM

- VALKOINEN / WHITE (-RAL 9016)  
■ MUSTA / BLACK (-RAL 9005)  
■ HARMAA / GREY (-RAL 9006)



VALOVIRRRAN YLLÄPITO / LIFETIME 55 000H (L80 B10)  
MATERIAALI / MATERIAL RUNKO PULVERIMAALATTUA ALUMIINIA / POWDER PAINTED ALUMINUM  
ASENNUS / INSTALLATION UPPOASENNUS / RECESSED



## Valaisin (LOR90%), netto

Teho W	Virta mA	2700K CRI90	3000K CRI90	3500K CRI90	4000K CRI90	Meat	Bakery
		CITILED COB Series Version3 CLU03Q-1208E1-272HSY2	Fortimo SLM C 930 P/W 1208 L15 2024 G7 HE+	Fortimo SLM C 935 P/W 1208 L15 2024 G7 HE+	Fortimo SLM C 940 P/W 1208 L15 2024 G7 HE	CITILED COB Series CLU038-1208C4-205HHK4	CITILED COB Series CLU038-1208C4-244HJK4
27	600	2735	2837	2927	2834	1501	1770
29	650	2963	3073	3171	3070	1626	1918
31	700	3191	3310	3415	3306	1751	2065
33	750	3419	3546	3659	3542	1876	2213

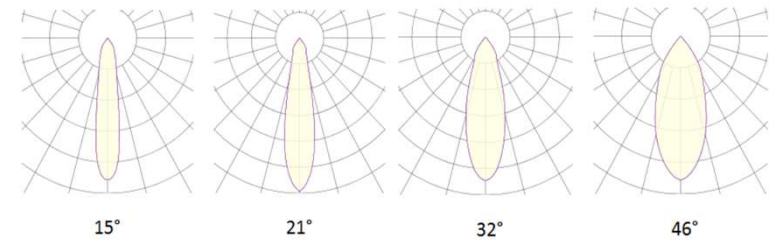

# LUNA DL SERIE

## LUNA C



## LUNA D



## LUNA T

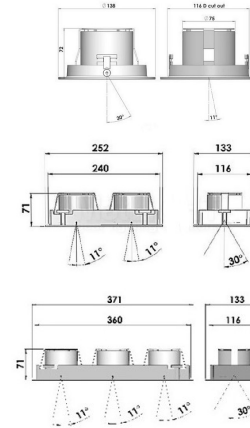

### TEKNISET TIEDOT / TECHNICAL INFORMATIONS

ON-OFF / DALI / CASAMBI / TRIAC  
 5 VUODEN TAKUU / 5 YEARS WARRANTY  
 MACADAMS 2 SDCM

- VALKOINEN / WHITE (-RAL 9016)
- MUSTA / BLACK (-RAL 9005)
- HARMAA / GREY (-RAL 9006)



VALOVIRRRAN YLLÄPITO / LIFETIME 55 000H (L80 B10)  
 MATERIAALI / MATERIAL RUNKO PULVERIMAALATTUA ALUMIINIA / POWDER PAINTED ALUMINUM  
 ASENNUS / INSTALLATION UPPOASENNUS / RECESSED



Valaisin (LOR90%), netto							
Teho	Virta	2700K CRI90	3000K CRI90	3500K CRI90	4000K CRI90	Meat	Bakery
W	mA	CITILED COB Series Version3 CLU030Q-1208E1-272HSY2	Fortimo SLMC 330 Pw/ 1208 L15 2024 G7 HE+	Fortimo SLM C 935 Pw/ 1208 L15 2024 G7 HE+	Fortimo SLM C 940 Pw/ 1208 L15 2024 G7 HE	CITILED COB Series CLU038-1208C4-205HHK4	CITILED COB Series CLU038-1208C4-244HJK4
27	600	2735	2837	2927	2834	1501	1770
29	650	2963	3073	3171	3070	1626	1918
31	700	3191	3310	3415	3306	1751	2065
33	750	3419	3546	3659	3542	1876	2213
35	800	3647	3782	3903	3778	2001	2361
36	850	3875	4019	4147	4014	2126	2508
38	900	4103	4255	4391	4250	2251	2656
40	950	4331	4492	4635	4487	2376	2803
42	1000	4559	4728	4879	4723	2501	2951
44	1050	4787	4964	5123	4959	2626	3098
53	1200	5470	5674	5854	5667	3002	3541

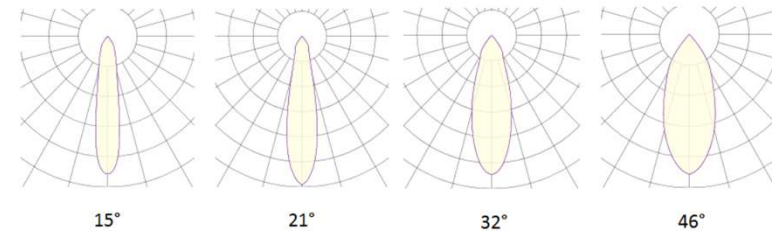



# FOCUS P

TEKNISET TIEDOT / TECHNICAL INFORMATION

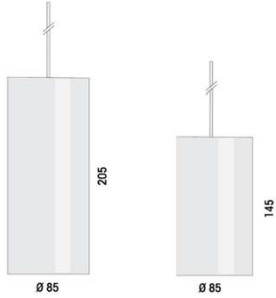

ON-OFF / DALI / CASAMBI / TRIAC  
5 VUODEN TAKUU / 5 YEARS WARRANTY  
MACADAMS 2 SDCM

- VALKOINEN / WHITE (-RAL 9016)
- MUSTA / BLACK (-RAL 9005)
- HARMAA / GREY (-RAL 9006)



VALOVIRRRAN YLLÄPITO / LIFETIME 55 000H (L80 B10)  
MATERIAALI / MATERIAL RUNKO PULVERIMAALATTUA ALUMIINIA / POWDER PAINTED ALUMINUM  
ASENNUS / INSTALLATION ROIKKUASENNUS / CEILING SUSPENDED



Valaisin (LOR90%), netto							
Teho W	Virta mA	2700K CRI90 <small>CITILED COB Series Version3 CLU03Q-1208E1-272HSY2</small>	3000K CRI90 <small>Fortimo SLMC 930 P/W 1208 L15 2024 G7 HE+</small>	3500K CRI90 <small>Fortimo SLMC 935 P/W 1208 L15 2024 G7 HE+</small>	4000K CRI90 <small>Fortimo SLMC 940 P/W 1208 L15 2024 G7 HE</small>	Meat <small>CITILED COB Series CLU038-1208C4-205HK4</small>	Bakery <small>CITILED COB Series CLU036-1208C4-244HK4</small>
13	300	1368	1418	1464	1417	750	885
15	350	1596	1655	1708	1653	875	1033
18	400	1823	1891	1951	1889	1001	1180
20	450	2051	2128	2195	2125	1126	1328
22	500	2279	2364	2439	2361	1251	1475
24	550	2507	2600	2683	2597	1376	1623
27	600	2735	2837	2927	2834	1501	1770
29	650	2963	3073	3171	3070	1626	1918
31	700	3191	3310	3415	3306	1751	2065
33	750	3419	3546	3659	3542	1876	2213
35	800	3647	3782	3903	3778	2001	2361
36	850	3875	4019	4147	4014	2126	2508

\*145 cm versio 750mA saakka / 145cm lighting fixture until 750 mA

Valonjakokäyrät 3D

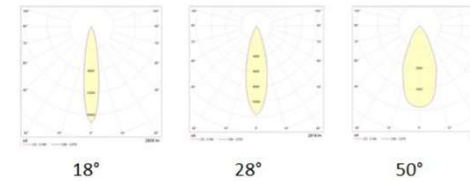

Valonjakokäyrät

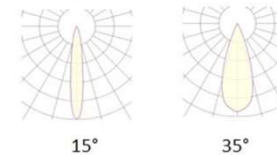

# HARMA

TEKNISET TIEDOT / TECHNICAL INFORMATION

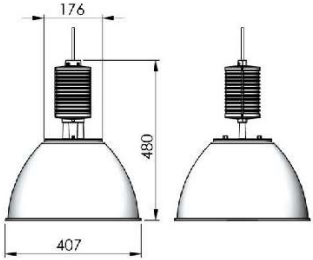

ON-OFF / DALI / CASAMBI / TRIAC  
 5 VUODEN TAKUU / 5 YEARS WARRANTY  
 MACADAMS 2 SDCM

- VALKOINEN / WHITE (-RAL 9016)
- MUSTA / BLACK (-RAL 9005)
- HARMAA / GREY (-RAL 9006)



VALOVIRRRAN YLLÄPITO / LIFETIME 55 000H (L80 B10)  
 MATERIAALI / MATERIAL RUNKO PULVERIMAALATTUA ALUMIINIA / POWDER PAINTED ALUMINUM  
 ASENNUS / INSTALLATION ROIKKUASENNUS / CEILING SUSPENDED

Valaisin (LOR90%), netto							
Teho W	Virta mA	2700K CRI90 <small>CITILED COB Series Version3 CLU03Q-1206E1+272H5V2</small>	3000K CRI90 <small>Fortimo SLM C 930 Pw 1208 L15 2024 G7 HE+</small>	3500K CRI90 <small>Fortimo SLM C 935 Pw 1208 L15 2024 G7 HE+</small>	4000K CRI90 <small>Fortimo SLM C 940 Pw 1208 L15 2024 G7 HE</small>	Meat <small>CITILED COB Series CLU038-1208C4-205H+K4</small>	Bakery <small>CITILED COB Series CLU038-1208C4-244H+K4</small>
13	300	1368	1418	1464	1417	750	885
15	350	1596	1655	1708	1653	875	1033
18	400	1823	1891	1951	1889	1001	1180
20	450	2051	2128	2195	2125	1126	1328
22	500	2279	2364	2439	2361	1251	1475
24	550	2507	2600	2683	2597	1376	1623
27	600	2735	2837	2927	2834	1501	1770
29	650	2963	3073	3171	3070	1626	1918
31	700	3191	3310	3415	3306	1751	2065
33	750	3419	3546	3659	3542	1876	2213
35	800	3647	3782	3903	3778	2001	2361
36	850	3875	4019	4147	4014	2126	2508
38	900	4103	4255	4391	4250	2251	2656
40	950	4331	4492	4635	4487	2376	2803
42	1000	4559	4728	4879	4723	2501	2951
44	1050	4787	4964	5123	4959	2626	3098
53	1200	5470	5674	5854	5667	3002	3541

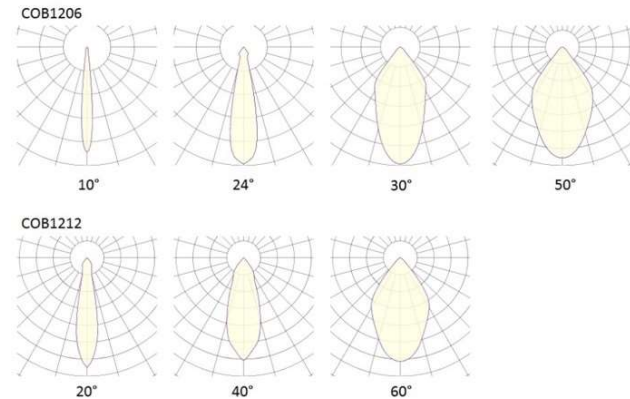





## SKILUX VALAISTUS

[www.skilux.fi](http://www.skilux.fi)

SKILUX – palvelevä valaisintukku. Yksityinen, 1998 perustettu, suomalainen valaisintukku palvelee kaikessa valaistukseen liittyvässä niin Suomessa kuin muuallakin Euroopassa. Skilux Oy on valaistuksen ammattilainen, joka auttaa kaikissa valotarpeissasi täsmällisesti ja luotettavasti. Monipuolinen tuotevalikoimamme koostuu huolella valituista, laadukkaista Euroopassa valmistetuista valaisintuotteista. Kosketinkiskot sekä osa edustamistamme valaisimista valmistetaan Suomessa. Vuosien kokemus ja toimiva logistiikka takaa täsmälliset toimitukset sekä parhaan lopputuloksen juuri sinun kohteesi tarpeisiin.

Skilux Oy - Ruosilantie 10 - 00390 Helsinki - asiakaspalvelu@skilux.fi - Puh. 020 743 4484